

Tub & Shower Fittings 154-LADCP

Product Type

Auto-Drain™ hose and hand spray, 1.5 GPM, with 36" ADA grab bar

Features & Specifications

- 1.5 GPM (5.7 L/min)
- 1.5 GPM hand spray with pause control; two 34" stainless steel hoses with Auto-Drain™
- 36" wall-mounted ADA grab bar with hand spray holder
- Hand spray with pause control, 1.5 GPM max.
- Complies with the requirements of the Buy American Act of 1933.



Performance Specification

- Rated Operating Pressure: 40-125 PSI
- Rated Operating Temperature: 40-120°F (Note: 180°F max. during temporary high-temperature system flush, maximum 30 minutes)

Warranty

- 5-Year Limited Cartridge Warranty
- Lifetime Limited Faucet Warranty
- 1-Year Limited Finish Warranty

Codes & Standards

-  ASME A112.18.1/CSA B125.1
-  ADA ANSI/ICC A117.1
-  Certified to WaterSense by ICC-ES

Job Name _____

Item Number _____

Section/Tag _____

Model Specified _____

Architect _____

Engineer _____

Contractor _____

Submitted as Shown

Submitted with Variations

Date _____



Architect/Engineer Specification

Chicago Faucets No. 154-LADCP, Auto-Drain™ hose assembly, 1.5 GPM (5.7 L/min) hand spray with pause control; two 34" stainless steel hoses with automatic hose drain and 36" wall-mounted ADA grab bar with hand spray holder. Must be used in combination with inline check valves to comply with ASSE 1014. This product meets ADA ANSI/ICC A117.1 requirements.

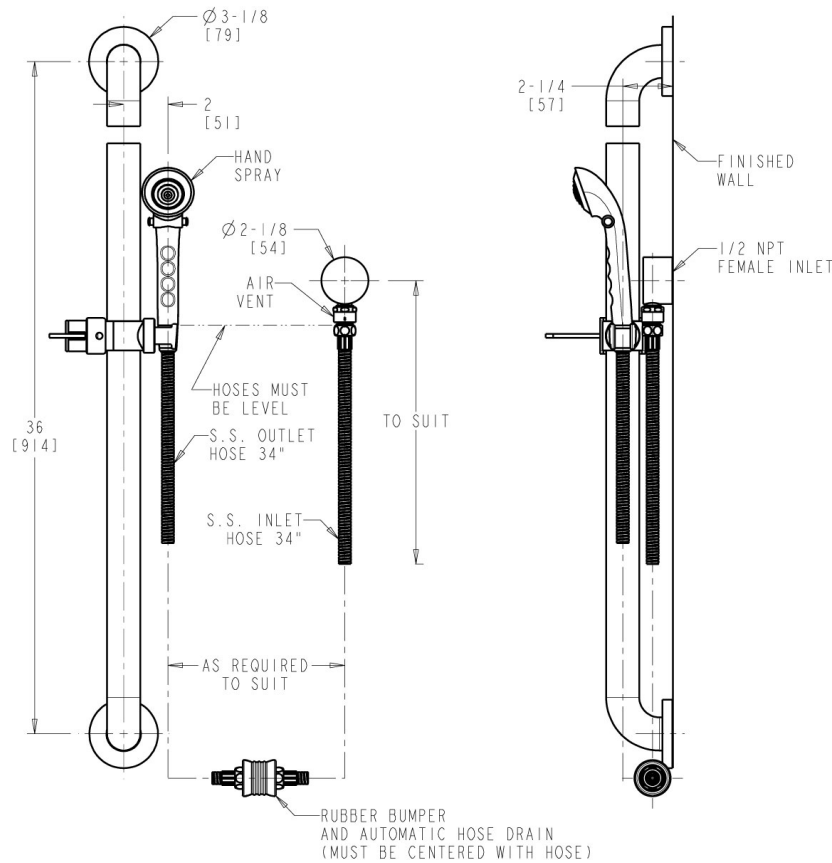

Operation and Maintenance

Installation should be in accordance with local plumbing codes. Flush all pipes thoroughly before installation. After installation, remove spout outlet or flow control and flush faucet thoroughly to clear any debris. Care should be taken when cleaning the product. Do not use abrasive cleaners, chemicals or solvents as they can result in surface damage. Use mild soap and warm water for cleaning and protecting the life of Chicago Faucet products. For specific operation and maintenance refer to the installation instructions and repair parts documents that are located at www.chicagofaucets.com.

Chicago Faucets, member of the Geberit Group, is the leading brand of commercial faucets and fittings in the United States, offering a complete range of products for schools, laboratories, hospitals, office buildings, food service, airports and sport facilities. Call 1.800.TECTRUE or 1.847.803.5000 Option 1 for installation or other technical assistance.

